

Schottky Barrier Rectifiers

Reverse Voltage - 45 Volts, Forward Current - 50 Ampere

CD50T45TDA

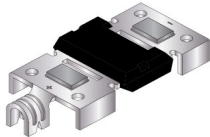

Module 012-A

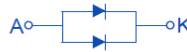

Module 012-A
Plastic Package
RoHS compliant

FEATURE:

1. The plastic package carries Underwriters Laboratory Flammability Classification 94V-0
2. Construction utilizes void-free molded plastic technique
3. Low reverse leakage
4. High forward surge current capability
5. High temperature soldering guaranteed:260°C, 10 seconds
6. High temperature manual soldering guaranteed:380°C, 5 seconds
7. With Tin Blocks.

ABSOLUTE MAXIMUM RATINGS (Ta = 25 °C Unless otherwise specified)

PARAMETER	SYMBOL	VALUE	UNIT
Maximum repetitive peak reverse voltage	V_{RRM}	45	V
Maximum RMS voltage	V_{RMS}	32	V
Maximum DC blocking voltage	V_{DC}	45	V
Maximum average forward rectified current (fig.1)	$I_{(AV)}$	50.0	A
Peak forward surge current 8.3ms single half sine-wave superimposed on rated load (JEDEC Method)	I_{FSM}	450	A
Maximum instantaneous forward voltage at 30A	V_F	0.48	V
Maximum DC reverse current $T_A=25^{\circ}C$	I_R	80	μA
at rated DC blocking voltage $T_A=100^{\circ}C$		20	mA
Rating for Fusing $1ms \leq t < 8.3ms$	I^2t	1038	A^2s
Typical thermal resistance ¹	$R_{\theta JC}$	1.0	$^{\circ}C/W$
Operating junction temperature range ²	T_J	-55 to +200	$^{\circ}C$
Storage temperature range	T_{STG}	-55 to +150	$^{\circ}C$

Note:

1. Thermal resistance from junction to case
2. In DC forward mode-forward operations without reverse bias, $t \leq 1$ h



Continental Device India Pvt. Limited

An IATF 16949, ISO9001 and ISO 14001/ISO 45001 Certified Company



TYPICAL CHARACTERISTIC CURVES

Fig 1: Forward Current Derating Curve

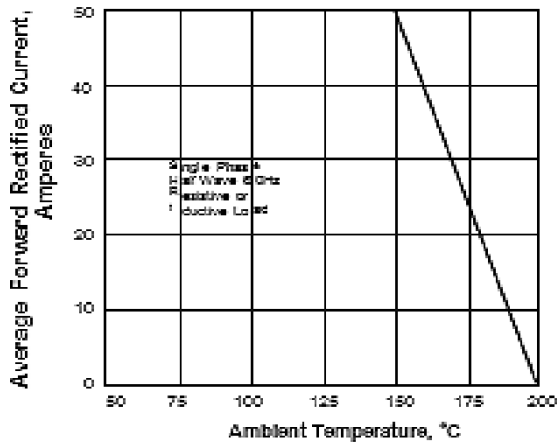

Fig 3: Maximum Non-repetitive Peak Forward Surge Current

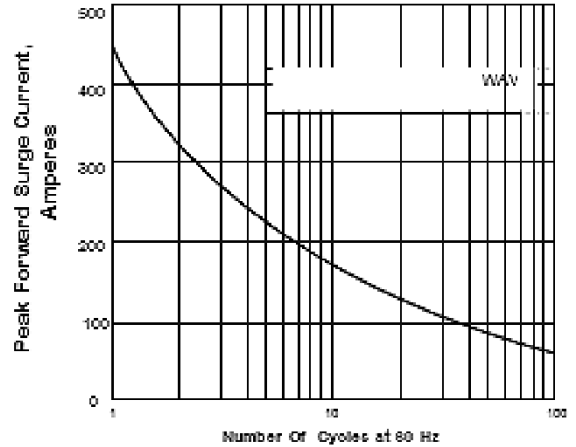

Fig 2: Typical Instantaneous Forward Characteristics

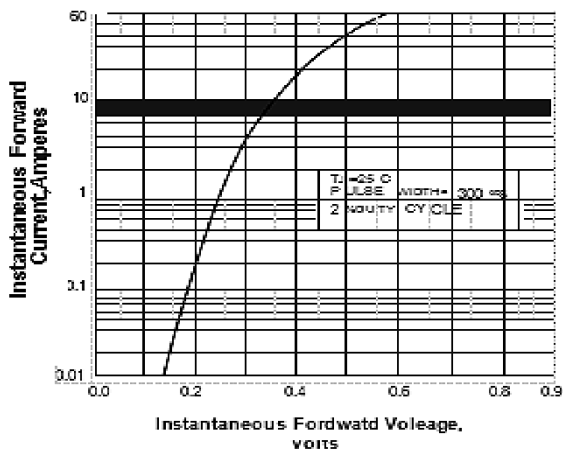
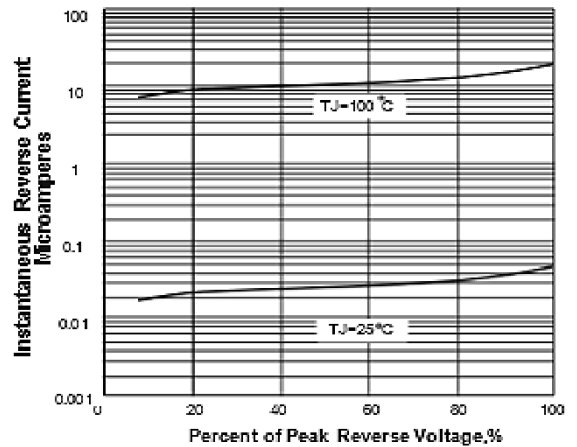
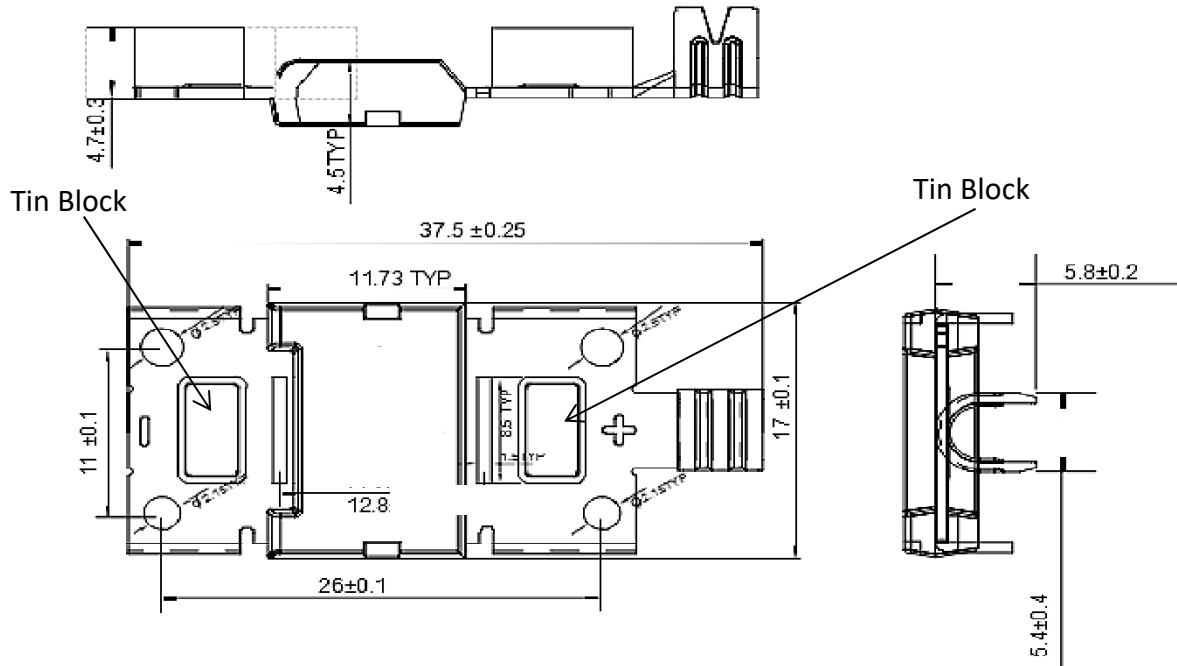

Fig 4: Typical Reverse Characteristics



PACKAGE DETAILS

Module 012-A



Dimensions in millimeters

Pin configuration



MECHANICAL DATA

Case : Module 012-A molded plastic body

Terminals : Leads solderable per MIL-STD-750, Method 2026

Polarity : As marked

Mounting Position : Any

Recommended Reflow Solder Profiles

The recommended reflow solder profiles for Pb and Pb-free devices are shown below.

Figure 1 shows the recommended solder profile for devices that have Pb-free terminal plating, and where a Pb-free solder is used.

Figure 2 shows the recommended solder profile for devices with Pb-free terminal plating used with leaded solder, or for devices with leaded terminal plating used with a leaded solder.

Figure 1

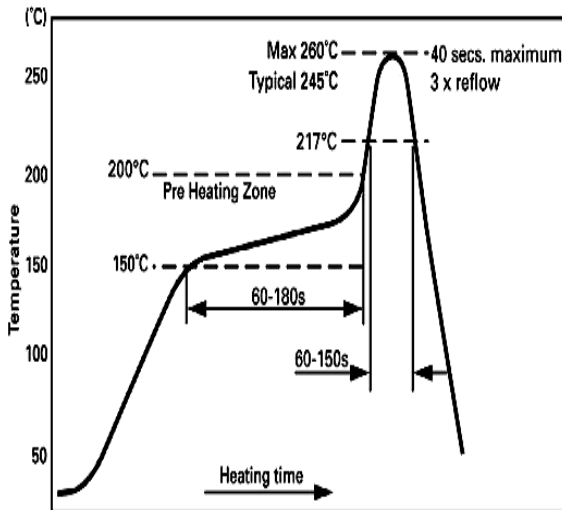
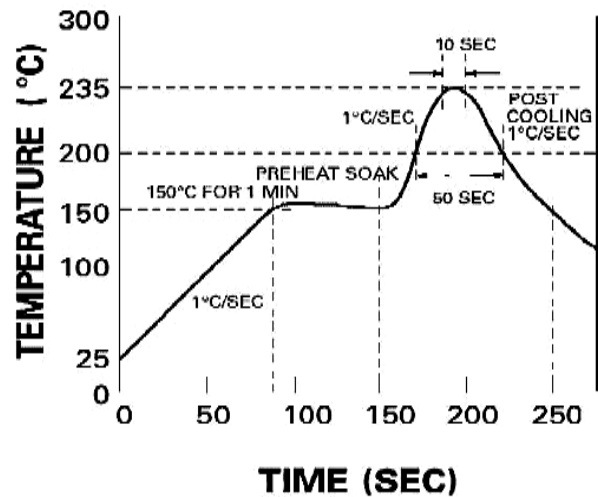

Figure 2



Reflow profiles in tabular form

Profile Feature	Sn-Pb System	Pb-Free System
Average Ramp-Up Rate	~3°C/second	~3°C/second
Preheat		
– Temperature Range	150-170°C	150-200°C
– Time	60-180 seconds	60-180 seconds
Time maintained above:		
– Temperature	200°C	217°C
– Time	30-50 seconds	60-150 seconds
Peak Temperature	235°C	260°C max.
Time within +0 -5°C of actual Peak	10 seconds	40 seconds
Ramp-Down Rate	3°C/second max.	6°C/second max.

Recommended Wave Solder Profiles

The Recommended solder Profile For Devices with Pb-free terminal plating where a Pb-free solder is used

The Recommended solder Profile For Devices with Pb-free terminal plating used with leaded solder, or for devices with leaded terminal plating used with leaded solder

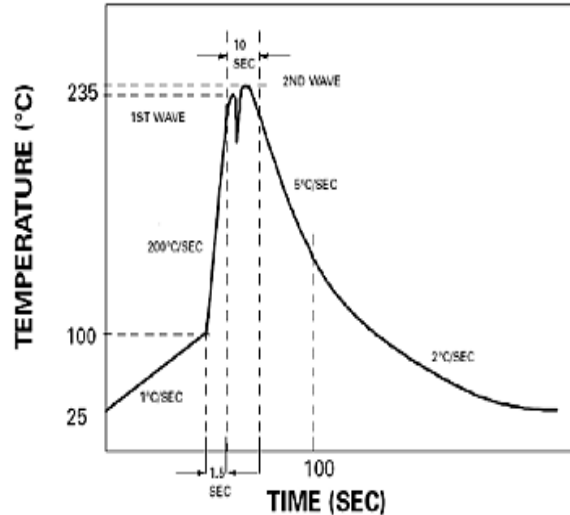
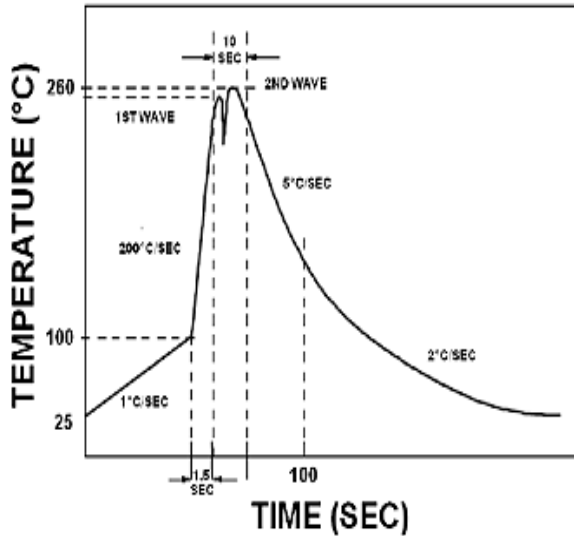

Wave Profiles in Tabular Form

Profile Feature	Sn-Pb System	Pb-Free System
Average Ramp-Up Rate	~200°C/second	~200°C/second
Heating rate during preheat	Typical 1-2, Max 4°C/sec	Typical 1-2, Max 4°C/Sec
Final preheat Temperature	Within 125°C of Solder Temp	Within 125°C of Solder Temp
Peak Temperature	235°C	260°C max.
Time within +0 -5°C of actual Peak	10 seconds	10 seconds
Ramp-Down Rate	5°C/second max.	5°C/second max



Continental Device India Pvt. Limited

An IATF 16949, ISO9001 and ISO 14001/ISO 45001 Certified Company



Recommended Product Storage Environment for Discrete Semiconductor Devices

This storage environment assumes that the Diodes and transistors are packed properly inside the original packing supplied by CDIL.

- Temperature 5 °C to 30 °C
- Humidity between 40 to 70 %RH
- Air should be clean.
- Avoid harmful gas or dust.
- Avoid outdoor exposure or storage in areas subject to rain or water spraying .
- Avoid storage in areas subject to corrosive gas or dust. Product shall not be stored in areas exposed to direct sunlight.
- Avoid rapid change of temperature.
- Avoid condensation.
- Mechanical stress such as vibration and impact shall be avoided.
- The product shall not be placed directly on the floor.
- The product shall be stored on a plane area. They should not be turned upside down. They should not be placed against the wall.

Shelf Life of CDIL Products

The shelf life of products is the period from product manufacture to shipment to customers. The product can be unconditionally shipped within this period. The period is defined as 2 years.

If products are stored longer than the shelf life of 2 years the products shall be subjected to quality check as per CDIL quality procedure.

The products are further warranted for another one year after the date of shipment subject to the above conditions in CDIL original packing.

Floor Life of CDIL Products and MSL Level

When the products are opened from the original packing, the floor life will start.

For this, the following JEDEC table may be referred:

JEDEC MSL Level		
Level	Time	Condition
1	Unlimited	≤30 °C / 85% RH
2	1 Year	≤30 °C / 60% RH
2a	4 Weeks	≤30 °C / 60% RH
3	168 Hours	≤30 °C / 60% RH
4	72 Hours	≤30 °C / 60% RH
5	48 Hours	≤30 °C / 60% RH
5a	24 Hours	≤30 °C / 60% RH
6	Time on Label(TOL)	≤30 °C / 60% RH



Continental Device India Pvt. Limited

An IATF 16949, ISO9001 and ISO 14001/ISO 45001 Certified Company



Customer Notes

Component Disposal Instructions

1. CDIL Semiconductor Devices are RoHS compliant, customers are requested to please dispose as per prevailing Environmental Legislation of their Country.
2. In Europe, please dispose as per EU Directive 2002/96/EC on Waste Electrical and Electronic Equipment (WEEE).

Disclaimer

The product information and the selection guides facilitate selection of the CDIL's Semiconductor Device(s) best suited for application in your product(s) as per your requirement. It is recommended that you completely review our Data Sheet(s) so as to confirm that the Device(s) meet functionality parameters for your application. The information furnished in the Data Sheet and on the CDIL Web Site/CD are believed to be accurate and reliable. CDIL however, does not assume responsibility for inaccuracies or incomplete information. Furthermore, CDIL does not assume liability whatsoever, arising out of the application or use of any CDIL product; neither does it convey any license under its patent rights nor rights of others. These products are not designed for use in life saving/support appliances or systems. CDIL customers selling these products (either as individual Semiconductor Devices or incorporated in their end products), in any life saving/support appliances or systems or applications do so at their own risk and CDIL will not be responsible for any damages resulting from such sale(s).

CDIL strives for continuous improvement and reserves the right to change the specifications of its products without prior notice.



CDIL is a registered trademark of

Continental Device India Pvt. Limited

C-120 Naraina Industrial Area, New Delhi 110 028, India.

Telephone +91-11-2579 6150, 4141 1112 Fax +91-11-2579 5290, 4141 1119

email@cdil.com www.cdil.com

CIN No. U32109DL1964PTC004291

CD50T45TDA
Rev1 13072023ERC